

2MP 44X Starlight Network PTZ Dome Camera

IPC6852SR-X44U



Key Features

Optics

- 44X Optical Zoom
- Starlight illumination
- Accurate and fast focusing
- Optical Defog Supported
- Up to 120 dB Optical WDR(Wide Dynamic Range)
- The Fifth-generation infrared technology, more than 250m (820ft) IR distance
- Optical glass window with higher light transmittance
- IR anti-reflection window to increase the infrared transmittance
- Smart IR
- EIS (Electronic Image Stabilization)

Compression

- Ultra 265,H.265, H.264, MJPEG
- Embedded smart algorithm
- Triple streams
- 1080P@60fps supported

Network

- ONVIF Conformance

Structure

- Innovative snow-removing functionality
- More effective heat dissipation system
- Intelligent temperature control technology
- 6 KV surge protection designed for network interface
- Fast Installing structure designed

Specifications

IPC6852SR-X44U					
Camera					
Sensor	1/2.8", progressive scan, 2.0 megapixel, CMOS				
Lens	5 ~ 220 mm , AF automatic focusing and motorized zoom lens				
Digital Zoom	16				
Optical Zoom	44				
DORI Distance	Lens	Detect(m)	Observe(m)	Recognize(m)	Identify(m)
	5mm	77.6	31	15.5	7.8
	220mm	3413.8	1365.5	682.8	341.4
Angle of View (H)	60.6°~ 1.8°				
Angle of View (V)	34.8°~0.8°				
Angle of View (O)	74.5°~2.1°				
Shutter	Auto/Manual; shutter time: 1/6 s ~ 1/100000 s				
Minimum Illumination	Colour: 0.001 lux (F1.2, AGC ON) 0 lux with IR				
Iris	Auto/Manual; F1.2 ~ F3.5				
Day/Night	IR-cut filter with auto switch (ICR)				
Digital noise reduction	2D/3D DNR				
S/N	>52dB				
IR Range	Up to 250m(820 ft)				
WDR	120dB				
Video					
Video Compression	Ultra 265, H.265, H.264, MJPEG				
H.264 code profile	Baseline profile, Main Profile, High Profile				
Frame Rate	Main Stream: 2MP (1920×1080): Max. 60 fps; Sub Stream: 2MP (1920×1080): Max. 60 fps; Third Stream: D1 (720×576): Max. 60 fps				
HLC	Supported				
BLC	Supported				

EIS	Supported
OSD	Up to 8 OSDs
Privacy Mask	Up to 24 areas
ROI	Up to 8 areas
Motion Detection	Up to 4 areas
Smart	
Behavior Detection	Intrusion, cross line, motion detection, Auto tracking
Intrusion	Enter and loiter in a pre-defined virtual region
cross line	Cross a pre-defined virtual line
motion detection	Moving within a pre-defined virtual region
auto tracking	Tracking the specified target
Recognition	Face detection、Audio detection
Intelligent Identification	Defocus, Scene Change
Statistical Analysis	People counting
General Function	Watermark, IP Address Filtering, Tampering Alarm, Alarm input, Alarm output, Access Policy, ARP Protection, RTSP Authentication, User Authentication
Audio	
Audio Compression	G.711
Two-way audio	Supported
Suppression	Supported
Sampling Rate	8 KHZ
Storage	
Edge Storage	Micro SD, up to 128GB
Network Storage	ANR
Network	
Protocols	IPv4, IGMP, ICMP, ARP, TCP, UDP, DHCP, PPPoE, RTP, RTSP, RTCP, DNS, DDNS, NTP, FTP, UPnP, HTTP, HTTPS, SMTP, 802.1x, SNMP
Compatible Integration	ONVIF(Profile S, Profile G), API
Pan & Tilt	
Pan Range	360° (endless)
Pan Speed	0.1°/s ~ 240°/s
	Preset speed: 300°/s
Tilt Range	-15° ~ +90° (auto reverse)
Tilt Speed	0.1° ~ 160°/s
	Preset speed: 240°/s
Number of Presets	1024
Patrol	Preset patrol, route patrol, recorded patrol
Home Position	Supported
Interface	
Audio I/O	Audio cable
	1 Input: impedance 35 kΩ; amplitude 2 V [p-p]
	1 Output: impedance 600 Ω; amplitude 2 V [p-p]
Alarm I/O	2 / 1
Serial Port	1 RS485
Network	1 RJ45 10M/100M Base-TX Ethernet

Video Output	1 BNC, impedance 75 Ω; amplitude 1 V [p-p]
General	
Power	24 V±25% AC (Default), 24 V±25% DC Power consumption:16 ~56W
Dimensions(∅xH)	∅270mm×496.7mm(∅10.6" x 19.6")
Weight	9.69kg(21.4lb)
Working Environment	-40°C~70°C(-40°F ~ 158°F), Humidity:10%~95% RH(non-condensing)
Ingress Protection	IP66
Heat	Built-in Heater and Temperature control system
Reset Button	Supported

Dimensions

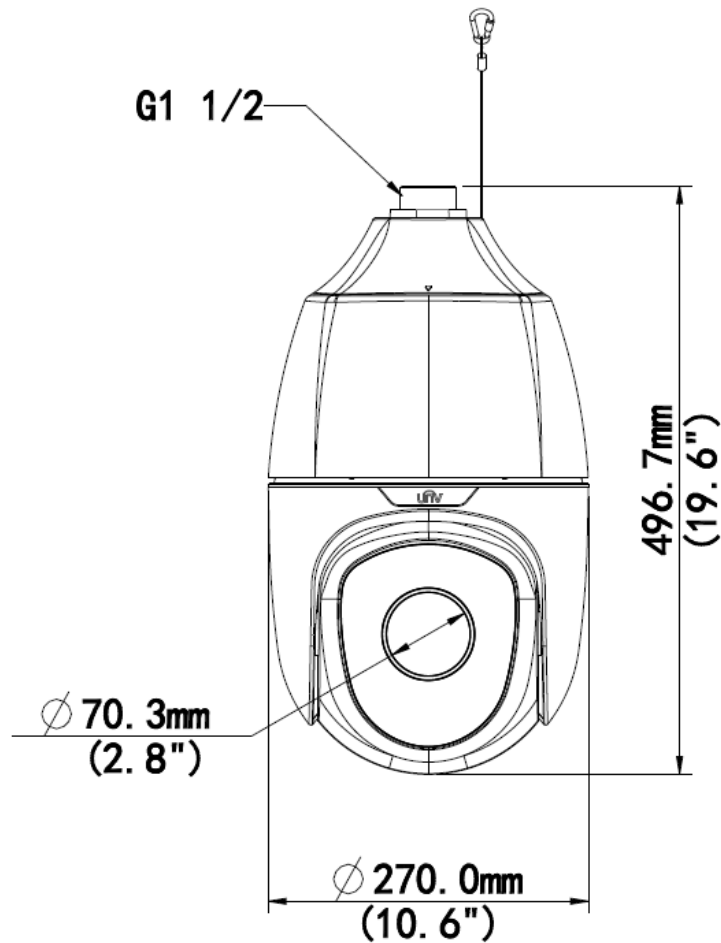

Accessories

Installation mode	Accessories	Description
Pendant mount	TR-CE45-IN bracket	/

Installation mode	Accessories	Description
	Pendant components: TR-UF45-A-IN ceiling plate TR-SE45-IN pendant rod (200mm) TR-SE45-A-IN pendant rod (500mm)	Ceiling plate is optional with different pendant rod for various applications
Standing pole mount	Customized bracket	The interface is designed with internal G1½ screws. The screw depth must be more than 23 mm.
Wall mount	TR-WE45-A-IN bracket	/
Corner mount	TR-WE45-A-IN bracket + TR-UC08-A/B-IN bracket	/
Pole mount	TR-WE45-A-IN bracket + TR-UP08-A/B-IN bracket	/

Zhejiang Uniview Technologies Co., Ltd.

Building No.10, Wanlun Science Park, Jiangling Road 88, Binjiang District, Hangzhou, Zhejiang, China (310051)

Email: overseasbusiness@uniview.com; globalsupport@uniview.com

<http://www.uniview.com>

©2016-2018 Zhejiang Uniview Technologies Co., Ltd. All rights reserved.

*Product specifications and availability are subject to change without notice