

2MP Starlight Fixed Bullet Network Camera

IPC2222SR5-UPF40 (60)-B



Key Features

Optics

- Starlight illumination
- Day/night functionality
- Smart IR , up to 50 m (164 ft) IR distance
- IR anti-reflection window to increase the infrared transmittance
- 2D/3D DNR (Digital Noise Reduction)

Compression

- Ultra265,H.265, H.264, MJPEG
- Embedded smart algorithm
- Triple streams
- ROI (Region of Interest)
- 9:16 corridor format

Network

- ONVIF Conformance

Structure

- Wide temperature range: -35°C to 60°C (-31°F to 140°F)
- Wide voltage range of $\pm 25\%$
- IP67

Specifications

	IPC2222SR5-UPF40-B	IPC2222SR5-UPF60-B
Camera		
Sensor	1/2.9", progressive scan, 2.0 megapixel, CMOS	
Lens	4.0mm@F1.6	6.0mm@F1.6
Angle of View(H)	76.6°	51.6°
Shutter	Auto/Manual, 1/6~1/100000 s	
Minimum Illumination	Colour: 0.002 Lux (F1.6, AGC ON) 0 Lux with IR on	
Day/Night	IR-cut filter with auto switch (ICR)	
Digital noise reduction	2D/3D DNR	
S/N	>52dB	
IR Range	Up to 50m (164 ft) IR range	
Defog	Digital Defog	
WDR	DWDR	
Video		
Video Compression	Ultra265, H.265, H.265, H.264, MJPEG	
H.264 code profile	Baseline profile, Main Profile, High Profile	
Frame Rate	Main Stream: 2MP (1920×1080): Max. 30 fps; Sub Stream: 2MP (1920×1080): Max. 30 fps; Third Stream: D1 (720×576): Max. 30 fps	
9:16 Corridor Mode	Supported	
ROI	Supported	
HLC	Supported	
OSD	Up to 8 OSDs	
Privacy Mask	Up to 8 areas	
ROI	Up to 8 areas	
Smart		
Behavior Detection	Intrusion, cross line, motion detection	
Intelligent Identification	Face detection, Defocus, Scene Change	
Statistical Analysis	People counting	
General Function	Watermark, IP Address Filtering, Tampering Alarm, Access Policy, ARP Protection, RTSP Authentication, User Authentication	
Storage		
Edge Storage	Micro SD, up to 128 GB	
Network Storage	ANR	
Network		
Protocols	IPv4, IGMP, ICMP, ARP, TCP, UDP, DHCP, PPPoE, RTP, RTSP, RTCP, DNS, DDNS, NTP, FTP, UPnP, HTTP, HTTPS, SMTP, 802.1x, SNMP	
Compatible Integration	ONVIF(Profile S, Profile G), API	
Interface		
Network	1 RJ45 10M/100M Base-TX Ethernet	
General		
Power	12 V DC±25%, PoE (IEEE802.3 af)	

	Power consumption: Max 9 W
Dimensions (L × W × H)	253.4 × 86 × 71.7 mm (9.98" × 3.4" × 2.8")
Weight	0.58kg (1.28lb)
Working Environment	-35°C ~ +60°C (-31°F ~ 140°F), Humidity:10%~95% RH(non-condensing)
Ingress Protection	IP67

Dimensions

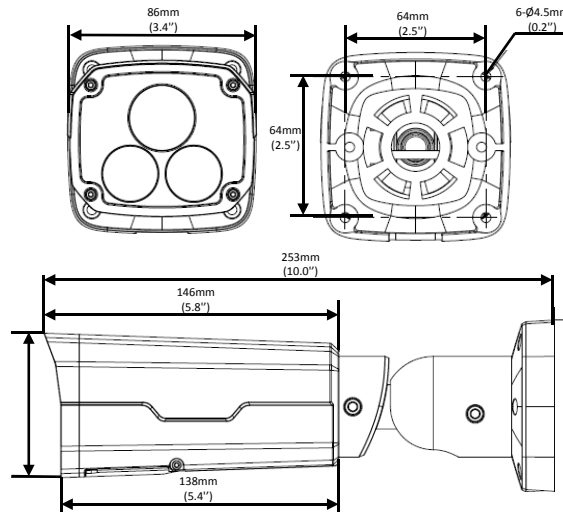

Accessories

Installation mode	Accessories	Description
Wall mount	\	Mounting pedestal is included in the Product package
Ceiling mount	\	Mounting pedestal is included in the Product package
Pole mount	TR-UP06-A-IN TR-JB07-IN junction box + TR-UP06-IN TR-JB07-A-IN junction box + TR-UP06-IN	TR-A01-IN waterproof joint for junction is optional

Zhejiang Uniview Technologies Co., Ltd.

Building No.10, Wanlun Science Park, Jiangling Road 88, Binjiang District, Hangzhou, Zhejiang, China (310051)

Email: overseasbusiness@uniview.com; globalsupport@uniview.com

<http://www.uniview.com>

©2016-2017 Zhejiang Uniview Technologies Co., Ltd. All rights reserved.

*Product specifications and availability are subject to change without notice.